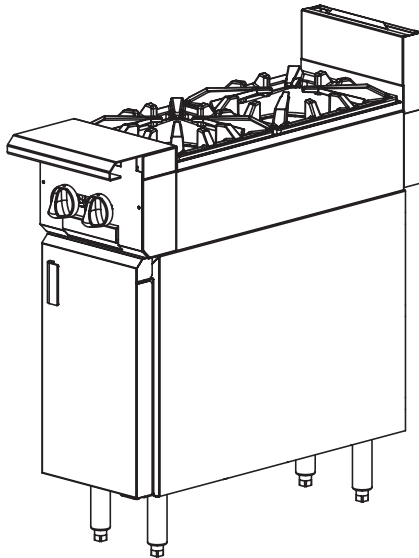

HEAVY DUTY COOKING**VULCAN****HEAVY DUTY GAS RANGE
12" WIDE, 2-BURNER**

Model V2B12B
(shown on cabinet base)

**SPECIFICATIONS**

12" wide heavy duty gas range, Vulcan Model No. V2B12 (modular) and V2B12B (cabinet base) or V2BU12 (modular) and V2BU12B (cabinet base). Stainless steel front, front top ledge, burner box, sides, base, and stub back and 6" adjustable legs. 1/4" diameter front gas manifold. Heavy cast aeration bowls with removable cast top grates. Front grate: 11½" x 11½", rear grate: 11½" x 14". Two 35,000 BTU/hr. heavy cast, two-piece open burners with individual pilots and controls for each burner. Total input 70,000 BTU/hr.

Exterior Dimensions:

36¾"d x 12"w x 36"h on 6" adjustable legs

- V2B12** 2-Burner / Modular
- V2B12B** 2-Burner / Cabinet Base
- V2BU12** 2-Burner Set-Up / Modular
- V2BU12B** 2-Burner Set-Up / Cabinet Base

STANDARD FEATURES

- Stainless steel front, front top ledge, burner box, sides, base, and stub back
- 1/4" diameter front gas manifold (not available with rear gas)
- 35,000 BTU/hr. open top burners with lift off heads
- Individual pilots and controls for each burner
- Heavy-duty cast grates
- 4" stainless steel stub riser
- 6" adjustable stainless steel legs for cabinet base units (no legs for modular models)
- Stainless steel cabinet base door
- One year limited parts and labor warranty

OPTIONAL FEATURES (Factory Installed)

- Cap and cover front manifold, left or right only, not both
- 4" adjustable flanged feet for modular models
- Less legs for dolly mounting of cabinet base models
- 3" high toe base for curb mounting

ACCESSORIES (Packaged & Sold Separately)

- ¾", 1", or 1¼" gas pressure regulator (specify gas type – pack loose)
- Set of 4 casters, 6" high (two locking)
- 6" adjustable flanged feet for cabinet base models
- Banking strip
- "S" Grates
- 10", 22", or 34" high back risers (no shelf)
- 22" single deck solid or flo-thru high shelf risers
- 34" double deck solid or flo-thru high shelf risers
- Flexible gas hose with quick disconnect and restraining device

VULCAN

a division of ITW Food Equipment Group LLC

P.O. Box 696 ■ Louisville, KY 40201 ■ Toll-free: 1-800-814-2028 ■ Local: 502-778-2791 ■ Quote & Order Fax: 1-800-444-0602



HEAVY DUTY GAS RANGE

12" WIDE, 2-BURNER

INSTALLATION INSTRUCTIONS

1. A properly sized gas pressure regulator suitable for battery or single unit application must be furnished and installed. Natural gas 6.0" W.C., propane gas 10.0" W.C.
2. An adequate ventilation system is required for commercial cooking equipment. Information may be obtained by writing to the National Fire Protection Association, 1 Batterymarch Park, Quincy, MA 02269, www.NFPA.org. When writing, refer to NFPA No. 96.
3. These units are manufactured for installation in accordance with ANSZ223.1A (latest edition), National Fuel Gas Code. Copies may be obtained from The American Gas Association, 400 N Capitol St. NW, Washington, DC 20001, www.AGA.org.
4. **Clearances**

	Rear	Sides
Combustible	10"	10"
Non-combustible	0"	0"
5. For proper combustion, install equipment on adjustable legs or casters. On curb or platform, allow 3½" front overhang. Toe base with leveling bolts are required for curb installation. Specify when ordering.
6. Cannot be battered with GH series equipment.
7. This appliance is manufactured for commercial installation only and is not intended for home use.

NOTE: In line with its policy to continually improve its product, Vulcan reserves the right to change materials and specifications without notice.

**Specify type of gas when ordering.
Specify altitude when above 2,000 feet.**

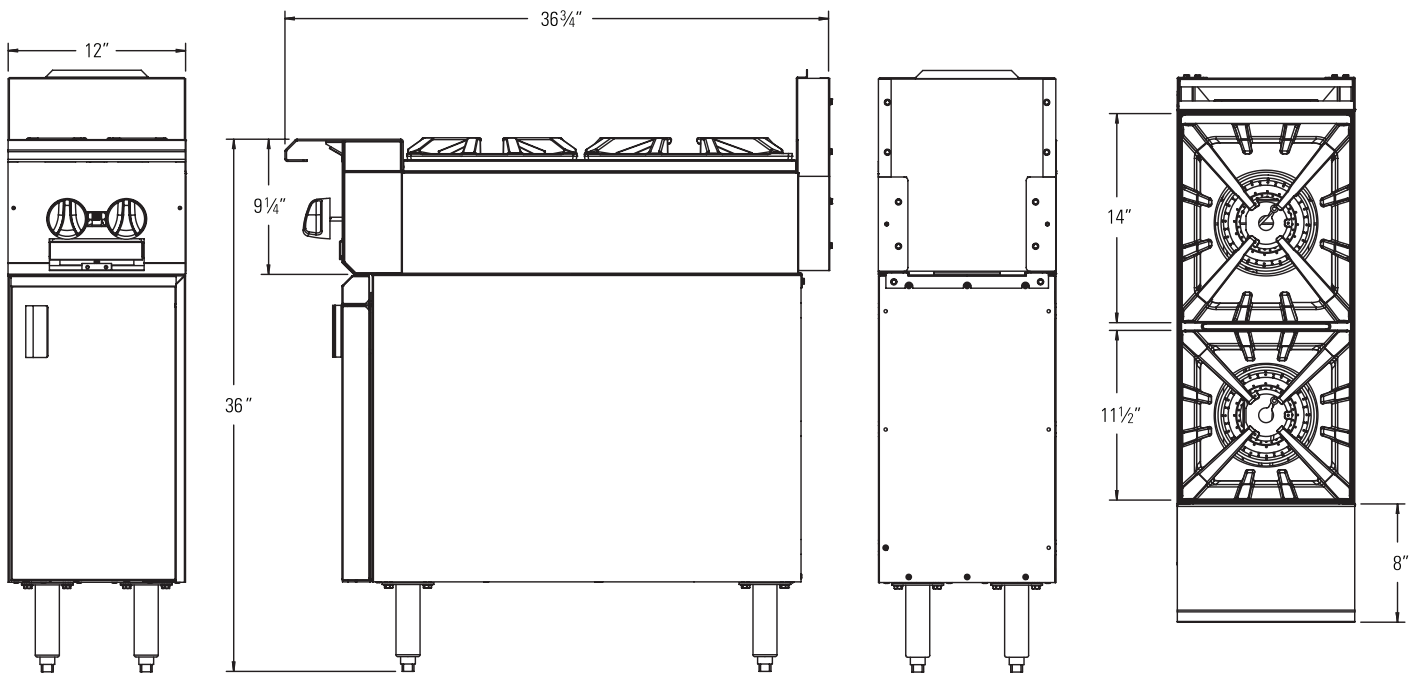

TOP CONFIGURATION	MODEL NUMBER	DESCRIPTION	TOTAL INPUT BTU / HR	SHIPPING WEIGHT LBS / KG
	V2B12	2-Burner / Modular	70,000	110 / 50
	V2B12B	2-Burner / Cabinet Base	70,000	160 / 73
	V2BU12	2-Burner / Step-Up / Modular	70,000	110 / 50
	V2BU12B	2-Burner / Step-Up / Cabinet Base	70,000	160 / 73

This appliance is manufactured for commercial use only and is not intended for home use.



a division of ITW Food Equipment Group LLC

P.O. Box 696 ■ Louisville, KY 40201 ■ Toll-free: 1-800-814-2028 ■ Local: 502-778-2791 ■ Quote & Order Fax: 1-800-444-0602

NOTE: In line with its policy to continually improve its products, Vulcan reserves the right to change materials and specifications without notice.